

# Hydrology and Irrigation Engineering (18CV63)

## Module – 1: Hydrology and Precipitation

### **Introduction:**

- **Hydrology** is the science that treats the waters of the earth, their occurrence, circulation and distribution, their chemical and physical properties and their reaction with the environment, including the relation to living things.
- The domain of hydrology embraces the full life history of water on the earth.

# Hydrology and Irrigation Engineering (18CV63)

## Module – 1: Hydrology and Precipitation

### **Definitions:**

**Hydrology:** is defined as science dealing with the occurrence, circulation, distribution and properties of the waters of the earth and its atmosphere.

or

**Hydrology:** is defined as Hydro (Water) + Logus (Science).

- Hydrology is further divided into: **Scientific and Engineering Hydrology.**

# Hydrology and Irrigation Engineering (18CV63)

## Module – 1: Hydrology and Precipitation

### **Definitions:**

**Scientific Hydrology:** deals with academic aspects.

**Engineering Hydrology:** deals with engineering applications as estimation of water resources, study of precipitation, runoff, evaporation and transpiration, study of problems such as floods and droughts.

**Climatology:** deals with the study of climate over given area within a specified period of time.

**Meteorology:** is branch of science dealing with the atmospheric phenomena.

# Hydrology and Irrigation Engineering (18CV63)

## Module – 1: Hydrology and Precipitation

### **Importance of Hydrology:**

- Structural and Hydraulic Design
- Municipal and Industrial Water Supply
- Irrigation
- Power
- Flood Control
- Navigation
- Erosion Control
- Pollution Control



# Hydrology and Irrigation Engineering (18CV63)

## Module – 1: Hydrology and Precipitation

### **Structural and Hydraulic Design:**

- For any type of reservoir a **spillway** of sufficient capacity is most essential.
- The capacity of the spillway, its height, downstream protection works etc. depend on the correct assessment of flood flow and routing.

**Note:** Spillway means a channel that carries excess water over or around a dam or other obstruction.

# Hydrology and Irrigation Engineering (18CV63)

## Module – 1: Hydrology and Precipitation

### **Municipal and Industrial Water Supply:**

- Due to constant increase in the urban and industrial water demands greater efforts are being made by hydrologists to meet the demands.

### **Irrigation:**

- Irrigation demands are similar to municipal and industrial water supply but on a larger scale.
- Hydrology plays an important role, to evaluate new projects in areas where the margin of safety is already low or to discover new source of water and its applications.

# Hydrology and Irrigation Engineering (18CV63)

## Module – 1: Hydrology and Precipitation

### **Power:**

- Hydrological studies are most essential for the operation of an Hydel project.
- For the storage plant, low seasonal flows rather than low daily flows are important and the reservoir draw down studies is must to determine the relative economics of various heights of the dam and power generating capacities.

# Hydrology and Irrigation Engineering (18CV63)

## Module – 1: Hydrology and Precipitation

### **Flood Control:**

- Flood control project range from small improvements like channel straightening to large project involving huge budget.
- Hence, for the large projects statistical and probabilistic flood frequency analysis are necessary.
- These studies would yield fruitful results in proper flood controlling methods.

# Hydrology and Irrigation Engineering (18CV63)

## Module – 1: Hydrology and Precipitation

### **Navigation:**

- When the stream is running through non – alluvial soils hydrological studies are relatively simple as the analysis involves hydraulic computation.
- However streams carrying sediment pose much more complex problems.

### **Erosion Control:**

- Proper hydrological investigations are necessary in the operation and maintenance of a reservoir increasing the life of the reservoir by reducing the silt entering it.

# Hydrology and Irrigation Engineering (18CV63)

## Module – 1: Hydrology and Precipitation

### **Pollution Control:**

- With the increase in population, large scale industrialization, the streams and rivers are getting polluted and are posing more and more danger to the public health, water life etc.
- Hence a complete stream pollution control study including an investigation of stream, particularly the magnitude and duration of low flows are found to be more useful.

# Hydrology and Irrigation Engineering (18CV63)

## Module – 1: Hydrology and Precipitation

### Global Water Distribution:

- The total water available on the earth is about  $140 \times 10^{16}$  meter<sup>3</sup>.
- Out of this 97% is contained in the oceans and sea as salt water, the remaining 3% is fresh water.
- Table from World Water Balance and Water Resources of the Earth, UNESCO, 1978.

Item	Area (10 <sup>6</sup> ) km <sup>2</sup>	Volume km <sup>3</sup>	Percent of total water	Percent of fresh water
Oceans	361.3	1,338,000,000	96.5	-

# Hydrology and Irrigation Engineering (18CV63)

## Module – 1: Hydrology and Precipitation

### Global Water Distribution:

Item	Area (10 <sup>6</sup> ) km <sup>2</sup>	Volume km <sup>3</sup>	Percent of total water	Percent of fresh water
<b>Ground Water</b>				
Fresh	134.8	10,530,000	0.76	30.1
Saline	134.8	12,870,000	0.93	-
Soil Moisture	82.0	16,500	0.0012	0.05
Polar Ice	16.0	24,023,500	1.7	68.6
Other ice and snow	0.3	340,600	0.025	1.0



# Hydrology and Irrigation Engineering (18CV63)

## Module – 1: Hydrology and Precipitation

### Global Water Distribution:

Item	Area (10 <sup>6</sup> ) km <sup>2</sup>	Volume km <sup>3</sup>	Percent of total water	Percent of fresh water
<b>Lakes</b>				
Fresh	1.2	91,000	0.007	0.26
Saline	0.8	85,400	0.006	-
Marshes	2.7	11,470	0.0008	0.03
Rivers	148.8	2,120	0.0002	0.006
Biological Water	510.0	1,120	0.0001	0.003
Atmospheric Water	510.0	12,900	0.001	0.04
Total Water	510.0	1,385,984,610	100	-
Fresh Water	148.8	35,029,210	2.5	100

# Hydrology and Irrigation Engineering (18CV63)

## Module – 1: Hydrology and Precipitation

### **Water Resources of India:**

- It is a fact that Asia's Water Supply is the lowest with an average annual runoff of only 17 cm.
- However India is well placed with  $16.83 \times 10^{11}$  meter<sup>3</sup> running off a total area of 369 million hectares, yielding an overall runoff 457 mm, almost same as the richest continent which gets 450 mm.
- But, the water supply in India is not well distributed as can be seen from table.
- Table shows the Surface water potential of India.

# Hydrology and Irrigation Engineering (18CV63)

## Module – 1: Hydrology and Precipitation

### Water Resources of India:

No.	River Basins	Water Potential million cubic meters
1	West flowing rivers (Rivers of Kerala, Tamil Nadu etc.)	305471.3
2	East flowing rivers (Kaveri basin, Mahanadi Ganga etc.)	355599.9
3	Indus basin	79473.1
4	Ganga basin (Chambal, Yamuna, Ramganga etc.)	550082.7
5	Brahmaputra and Barak basins	590713.6
	Total	1881340.6

# Hydrology and Irrigation Engineering (18CV63)

## Module – 1: Hydrology and Precipitation

### Water Resources of India:

No.	Region	Catchment area 1000 km <sup>2</sup>	Annual Runoff cm
1	Rivers falling into Arabian Sea (except the Indus system)	481	63
2	Indus basin in India	354	22
3	Rivers falling into Bay of Bengal (except Ganga and Brahmaputra)	1210	34
4	Ganga System	978	50
5	Brahmaputra System	506	75

# Hydrology and Irrigation Engineering (18CV63)

## Module – 1: Hydrology and Precipitation

### **Practical Application of Hydrology:**

The applications of hydrology are:

- Hydrology is used to estimate the probable maximum flood at a proposed site of dam, bridge etc.
- The variation of water production from a catchment can be calculated and described by hydrology.
- Engineering hydrology helps in determining the relation between a catchment surface water and ground water resources.

# Hydrology and Irrigation Engineering (18CV63)

## Module – 1: Hydrology and Precipitation

### **Practical Application of Hydrology:**

The applications of hydrology are:

- The expected flood flows over a spillway at an highway culvert, or in an urban storm drainage system can be known through hydrology.
- Hydrology helps us to know the required reservoir capacity in order to assure adequate water for irrigation or municipal water supply in drought conditions.
- Hydrology helps in the design of river training works.

# Hydrology and Irrigation Engineering (18CV63)

## Module – 1: Hydrology and Precipitation

### **Practical Application of Hydrology:**

The applications of hydrology are:

- Dependable yields from the stream for generation of hydroelectric power can be calculated.
- Water supply to township and sewerage schemes can be properly designed.
- Water resources account of a river basin can be prepared.
- Operation of reservoirs can be done in an efficient manner.

# Hydrology and Irrigation Engineering (18CV63)

## Module – 1: Hydrology and Precipitation

### Hydrologic Cycle:

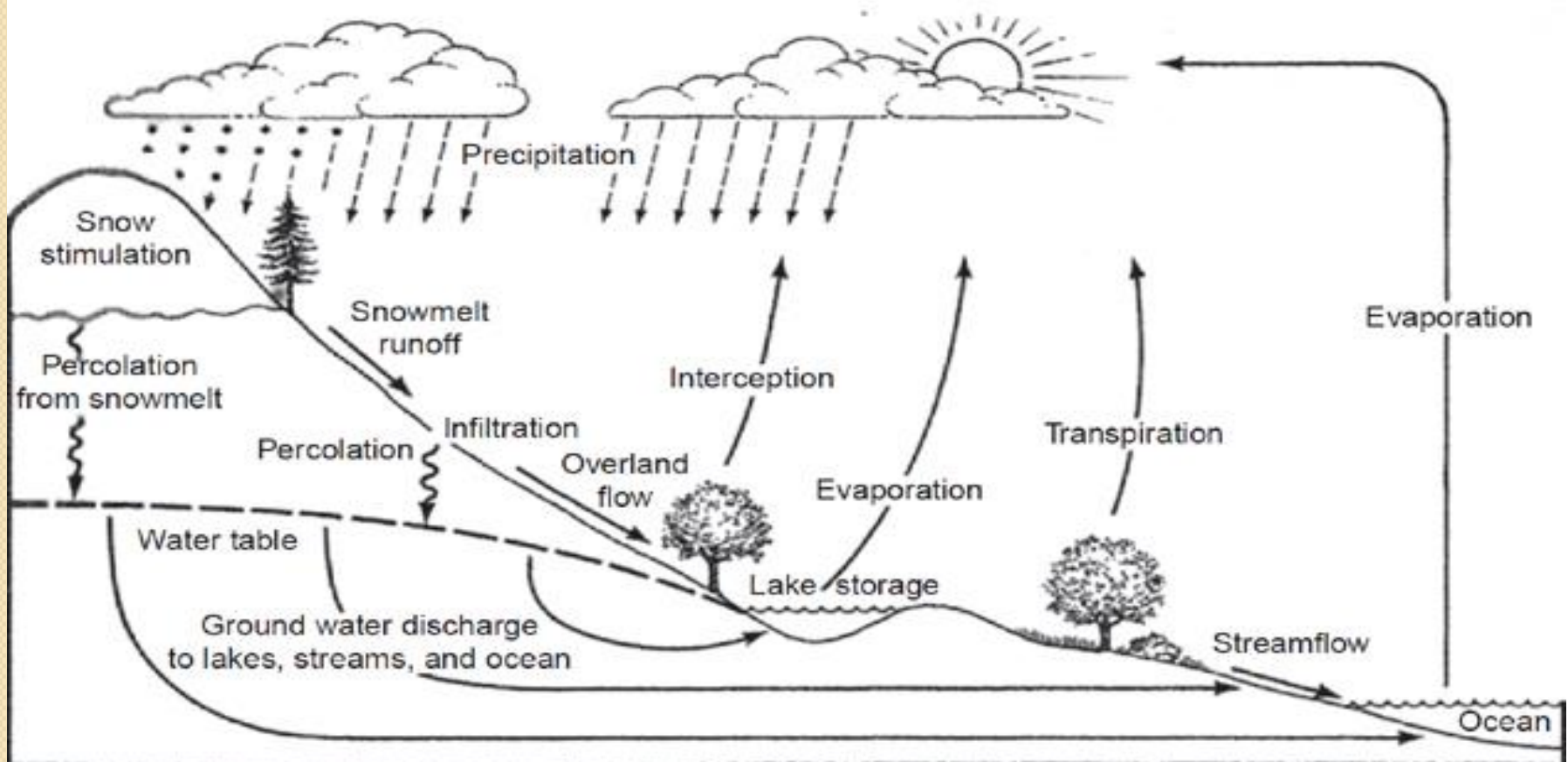



# Hydrology and Irrigation Engineering (18CV63)

## Module – 1: Hydrology and Precipitation

### **Hydrologic Cycle:**

- The natural sequence through which water passes into the atmosphere as water vapour, precipitates to earth in liquid or solid form and ultimately return to the atmosphere through evaporation.

or

- The sequence of condition through which water passes from vapor in the atmosphere through precipitation upon land or water surfaces and ultimately back into the atmosphere as a result of evaporation and transpiration.

# Hydrology and Irrigation Engineering (18CV63)

## Module – 1: Hydrology and Precipitation

### **Hydrologic Cycle:**

The hydrologic cycle consists of following processes:

- Evaporation and Transpiration
- Precipitation
- Runoff
- Interflow or Sub-surface runoff
- Ground water flow or Base flow

# Hydrology and Irrigation Engineering (18CV63)

## Module – 1: Hydrology and Precipitation

### Hydrologic Cycle:

#### Evaporation and Transpiration:

- Due to Sun's radiation the water from the surface of Seas, Oceans, Rivers and Lakes get evaporated.
- Where as the **transpiration** is the process of water getting lost from the plants/vegetation.

#### Precipitation:

- It can be defined as the fall of moisture from the atmosphere to the earth's surface in any form either liquid or solid.

# Hydrology and Irrigation Engineering (18CV63)

## Module – 1: Hydrology and Precipitation

### **Hydrologic Cycle:**

#### **Runoff:**

- It is the portion of precipitation which makes way towards the sea or ocean either as surface or subsurface water.
- Surface runoff is the water flowing over land.

#### **Interflow or Sub-surface Runoff:**

- Is the portion of precipitation in filtering into the surface soil and depending upon the geology of the place runs as sub-surface runoff and hence joins the streams and rivers.

# Hydrology and Irrigation Engineering (18CV63)

## Module – 1: Hydrology and Precipitation

### Hydrologic Cycle:

#### Ground Water Flow or Base Flow:

- Is the portion of precipitation which after in filtration, percolates down and joins the ground water reservoir that ultimately connects the sea or ocean.
- Hence, the hydrologic cycle can be mathematically expressed as:

$$\mathbf{P = R + E + S}$$

Where, P = Precipitation, R = Surface and Sub-surface runoff, E = Total evaporation, S = Surface and Subsurface storage of water.

# Hydrology and Irrigation Engineering (18CV63)

## Module – 1: Hydrology and Precipitation

### Horton's HC:

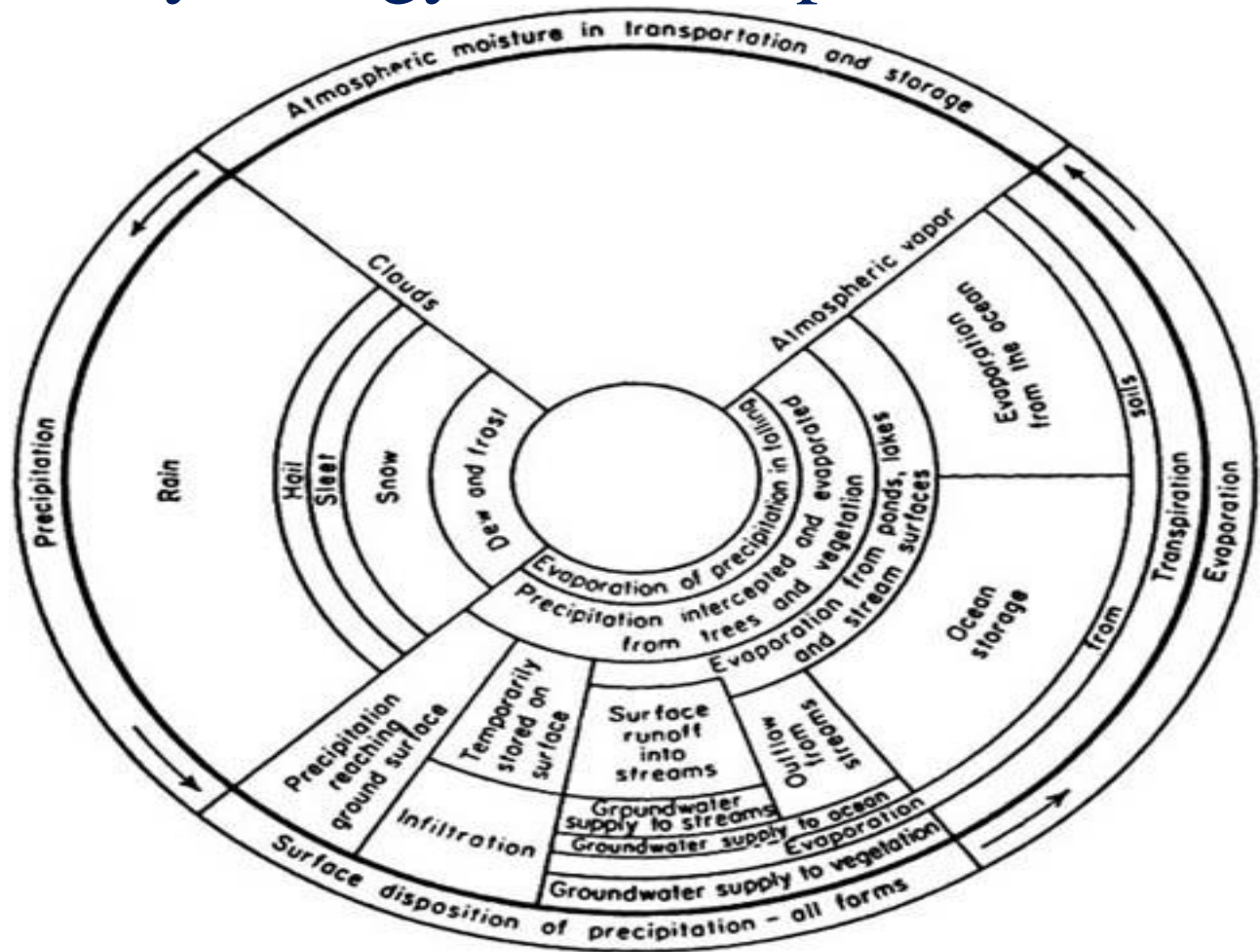



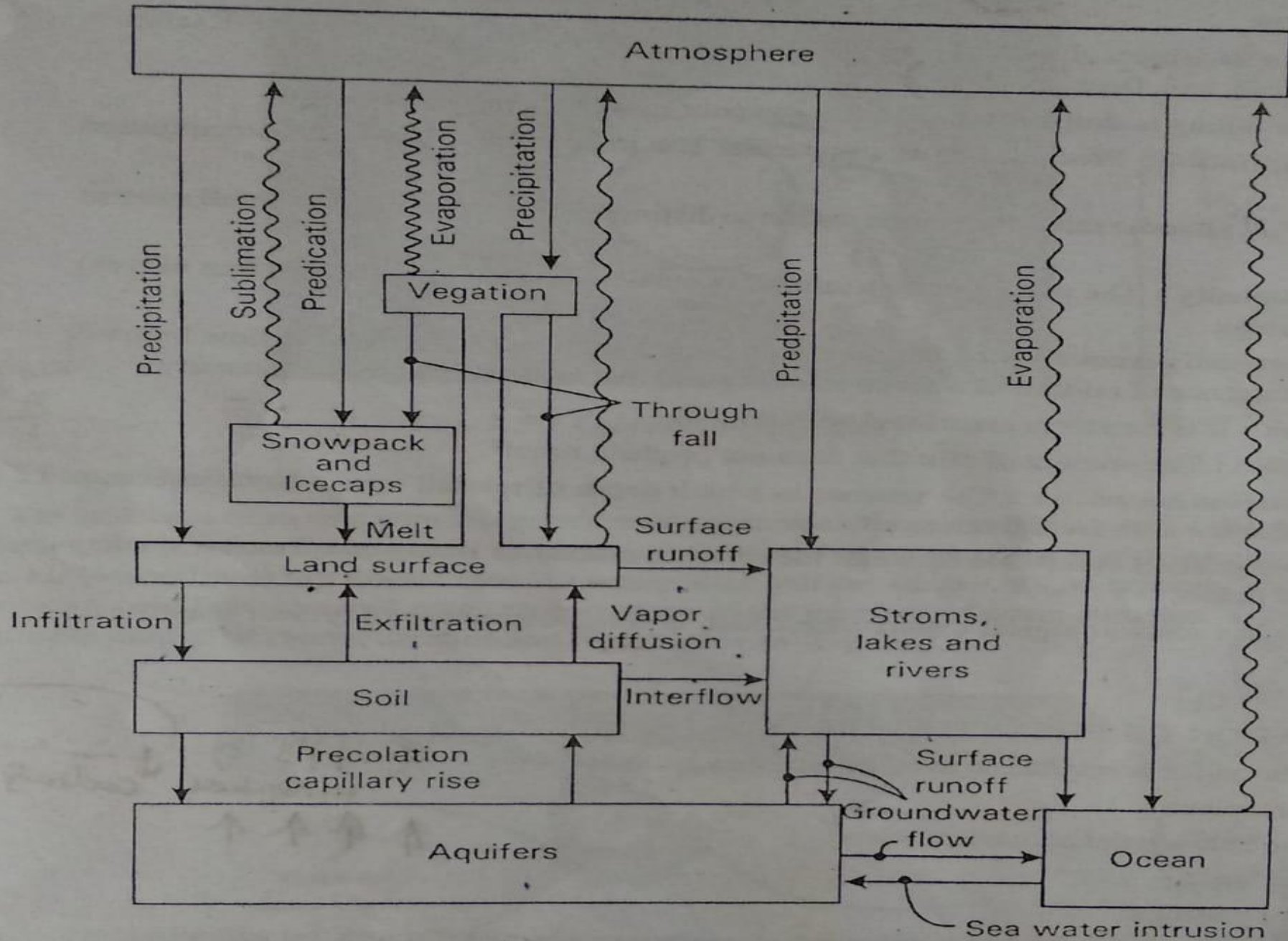

*Fig. 1.2(b) Horton's representation of Hydrologic cycle*

# Hydrology and Irrigation Engineering (18CV63)

## Module – 1: Hydrology and Precipitation

### Introduction to Precipitation:

- Precipitation is any form of solid or liquid water that falls from the atmosphere to the earth's surface.
- In India, **rain** is the most common of precipitation.
- Formation of precipitation requires lifting of air mass so that it cools and condenses.

### Definitions:

**Precipitation:** denotes all forms of water that reach the earth from the atmosphere. Examples: rainfall, snowfall, frost etc.

**Rain:** water falling in drops condensed from vapor.



# Hydrology and Irrigation Engineering (18CV63)

## Module – 1: Hydrology and Precipitation

### **Formation of Precipitation:**

The condition for precipitation to take place may be follows:

- Supply of moisture
- Cooling to below point of condensation
- Condensation
- Growth of particles

The supply of moisture is obtained through evaporation from wet surfaces, transpiration from vegetation or transport from elsewhere. The cooling of moist air may be through contact with a cold earth surface causing dew, mist or fog etc.

# Hydrology and Irrigation Engineering (18CV63)

## Module – 1: Hydrology and Precipitation

### **Forms of Precipitation:**

The various forms of precipitation are:

- Drizzle
- Rain
- Glaze
- Sleet
- Snow
- Snow flake
- Hail

# Hydrology and Irrigation Engineering (18CV63)

## Module – 1: Hydrology and Precipitation

### Forms of Precipitation:

- **Drizzle:** these are water drops which are less than 0.5 mm in diameter and the intensity less than 1 mm per hour.
- **Rain:** these are water drops which are more than 0.5 mm and less than 6 mm in diameter. Light rain – 2.5mm/h, Moderate rain – 2.5 to 7.5mm/h and Heavy rain –  $> 7.5$ mm/h.
- **Glaze:** it is the ice coating formed when drizzle or rain freezes as it comes in contact with cold objects on the ground.

# Hydrology and Irrigation Engineering (18CV63)

## Module – 1: Hydrology and Precipitation

### Forms of Precipitation:

- **Sleet:** it is the frozen rain drop cooled to the ice stage while falling through the air at subfreezing temperature.
- **Snow:** it is the precipitation in the form of ice crystals, when the water vapor directly becomes ice.
- **Snow Flake:** ice crystals fused together represent snow flake.
- **Hail:** it is the precipitation in the form of ice balls or lumps of ice whose diameter is more than 5mm. These are formed by alternate freezing and melting process.

# Hydrology and Irrigation Engineering (18CV63)

## Module – 1: Hydrology and Precipitation

### **Types of Precipitation:**

- Convective Precipitation
- Orographic Precipitation
- Front Lining
- Cyclones
- Convergence

# Hydrology and Irrigation Engineering (18CV63)

## Module – 1: Hydrology and Precipitation

### Convective Precipitation:

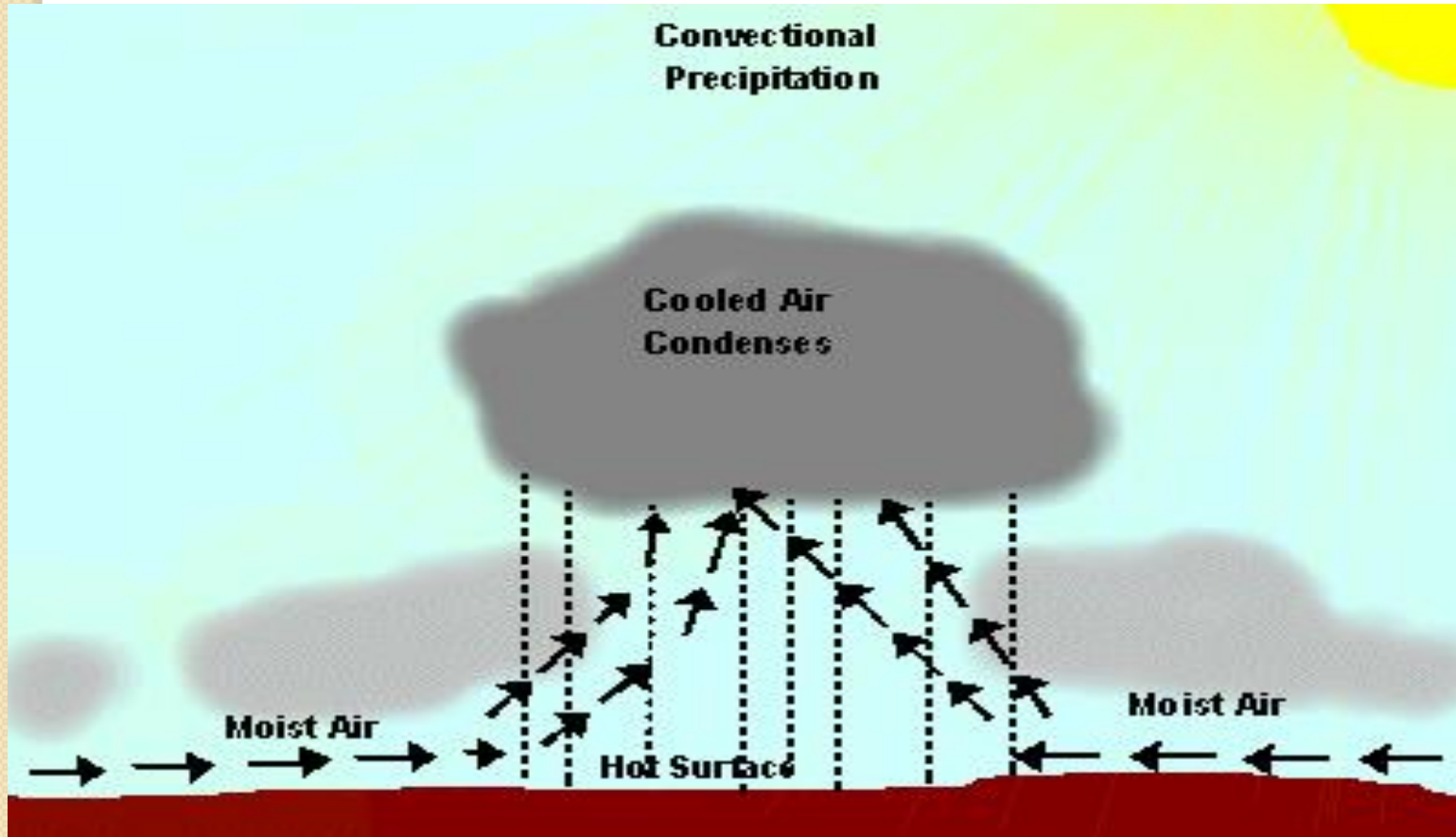

# Hydrology and Irrigation Engineering (18CV63)

## Module – 1: Hydrology and Precipitation

### **Convective Precipitation:**

- This is caused by the rising of warmer, lighter air in colder denser surroundings.
- The difference in temperature results in unequal heating cooling at the top of the air layer or mechanical lifting when the air is forced to pass over denser, colder air mass or over mountain barrier.



# Hydrology and Irrigation Engineering (18CV63)

## Module – 1: Hydrology and Precipitation

### Orographic Precipitation:

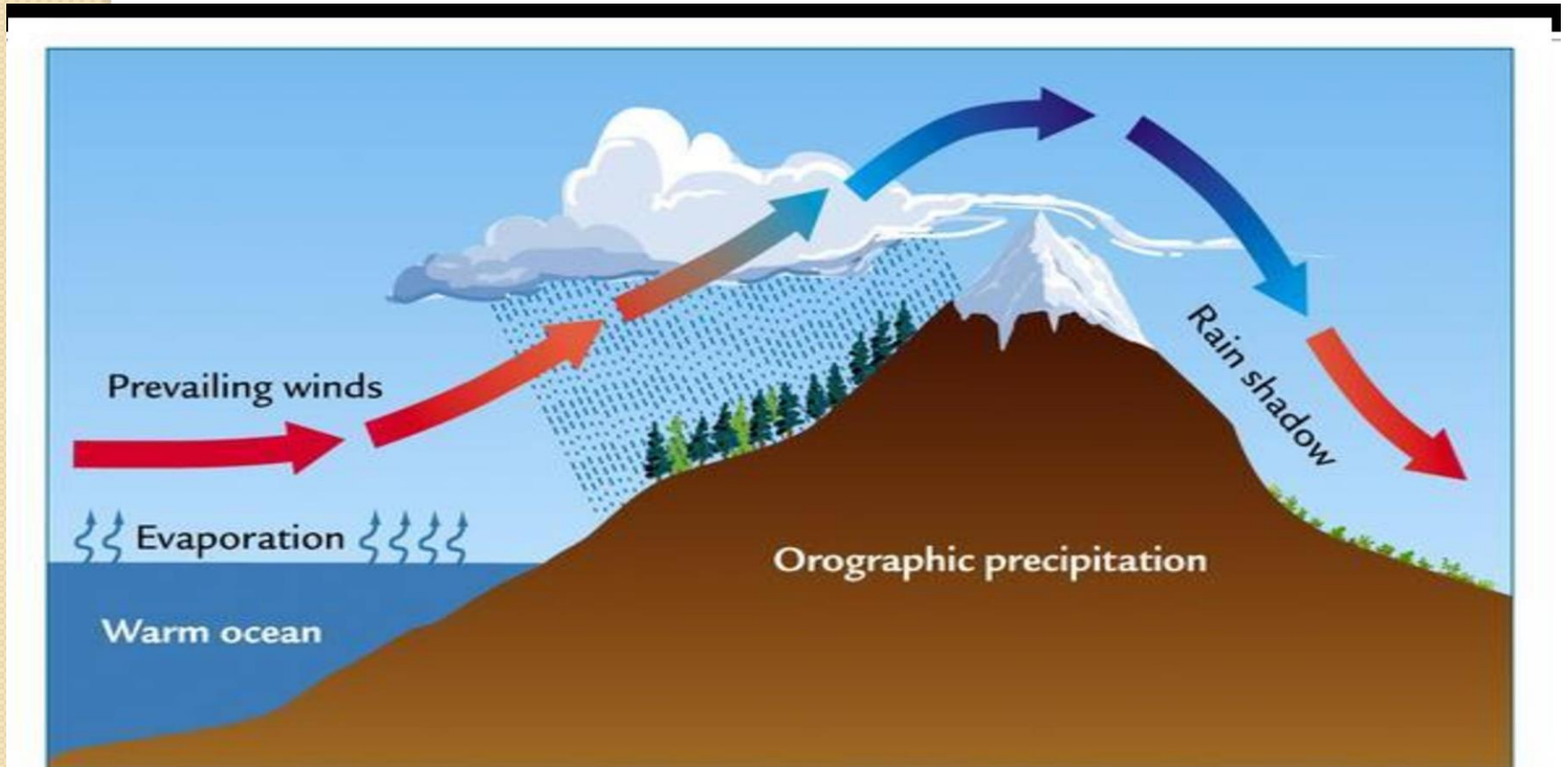



# Hydrology and Irrigation Engineering (18CV63)

## Module – 1: Hydrology and Precipitation

### **Orographic Precipitation:**

- The moist air masses get lifted to higher altitudes and hence undergo cooling condensation and finally precipitation occurs.
- Thus in mountain range, the windward slopes tend to have heavy precipitation when compared to the backward slopes.

# Hydrology and Irrigation Engineering (18CV63)

## Module – 1: Hydrology and Precipitation

### Frontal Lifting Precipitation:

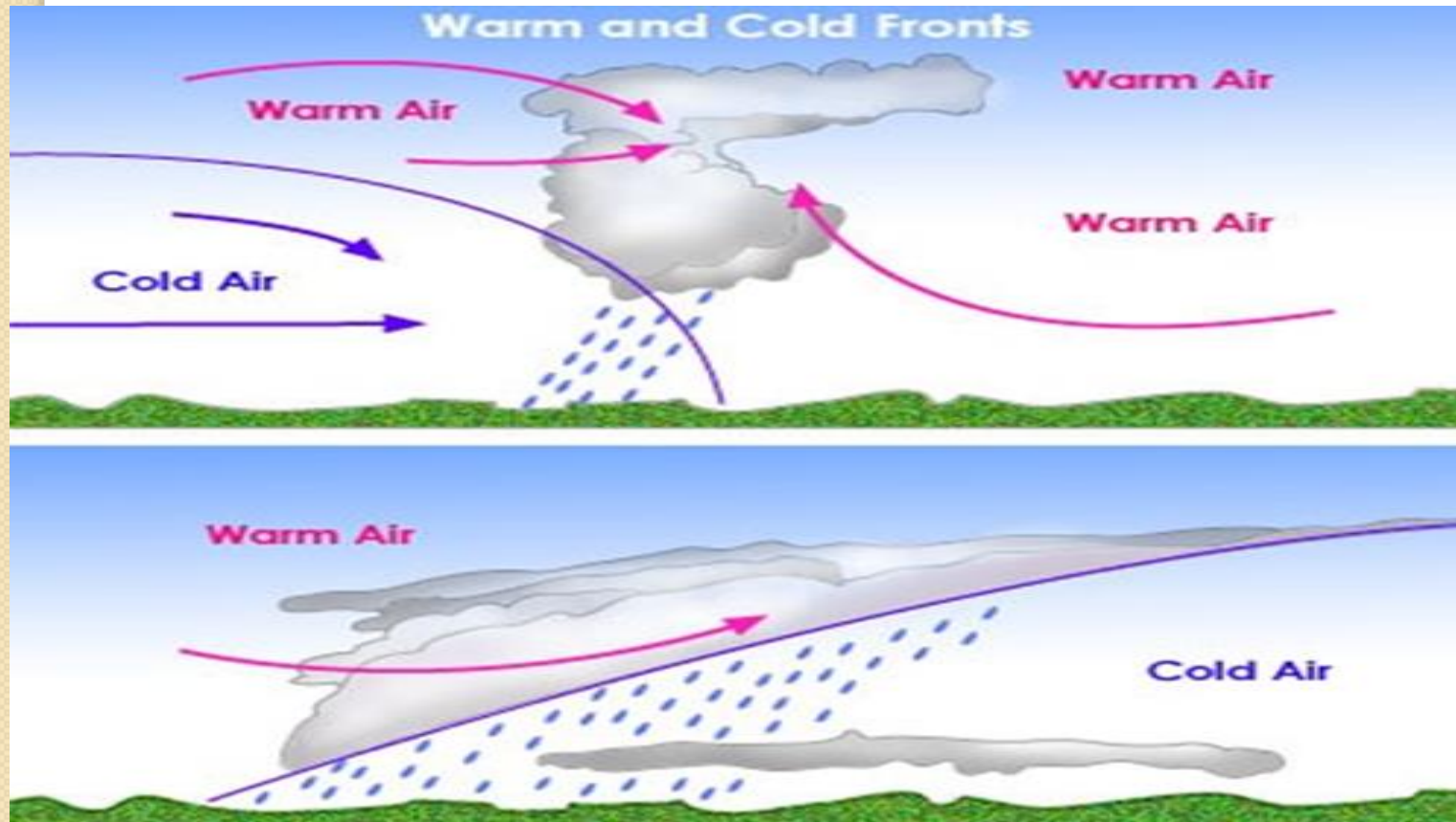

# Hydrology and Irrigation Engineering (18CV63)

## Module – 1: Hydrology and Precipitation

### **Frontal Lifting Precipitation:**

- The existence of an area with low pressure causes surrounding air to move into the depression, displacing low pressure air upwards, which may then be cooled to dew point.
- If cold is replaced by warm air the frontal zone is usually large and the rainfall of low intensity and long duration.
- A cold front shows a much steeper slope of the interface of warm and cold air usually resulting in rainfall of shorter duration and higher intensity.

# Hydrology and Irrigation Engineering (18CV63)

## Module – 1: Hydrology and Precipitation

### **Cyclonic Precipitation:**

- These are active depression, which gain energy while moving over warm ocean water and which dissipate energy while moving over land or cold water.
- They may cause rains and heavy storms.
- Typical characteristics of these tropical depression are high intensity rainfall of long duration (several days).
- Notorious tropical depression occur in the Caribbean.
- The Bay of Bengal (monsoon depression), The Far East (Typhoons), Southern Africa (Cyclones) and an island of the pacific (cyclones, willi – willies).

# Hydrology and Irrigation Engineering (18CV63)

## Module – 1: Hydrology and Precipitation

### **Convergence:**

- The Inter – Tropical Convergence Zone (ITCZ) is the tropical region where the air masses originating from the Tropics of Cancer and Capricorn converge and meet.
- In the tropics, the position of the ITCZ governs the occurrence of wet and dry seasons.
- This convergence zone moves with seasons.
- In July, the ITCZ lies to the North of the equator and in January it lies to the South.

# Hydrology and Irrigation Engineering (18CV63)

## Module – 1: Hydrology and Precipitation

### **Convergence:**

- In the tropics the position of the ITCZ determines the main rain bringing mechanism which is also called monsoon.
- Hence, the ITCZ is also called as the monsoon Trough, particularly is Asia.

# Hydrology and Irrigation Engineering (18CV63)

## Module – 1: Hydrology and Precipitation

### **Measurement of Precipitation:**

- Non Recording type of Raingauge
- Recording Gauges
- Syphon type Raingauge



# Hydrology and Irrigation Engineering (18CV63)

## Module – 1: Hydrology and Precipitation

### Non Recording Type of Raingauge:

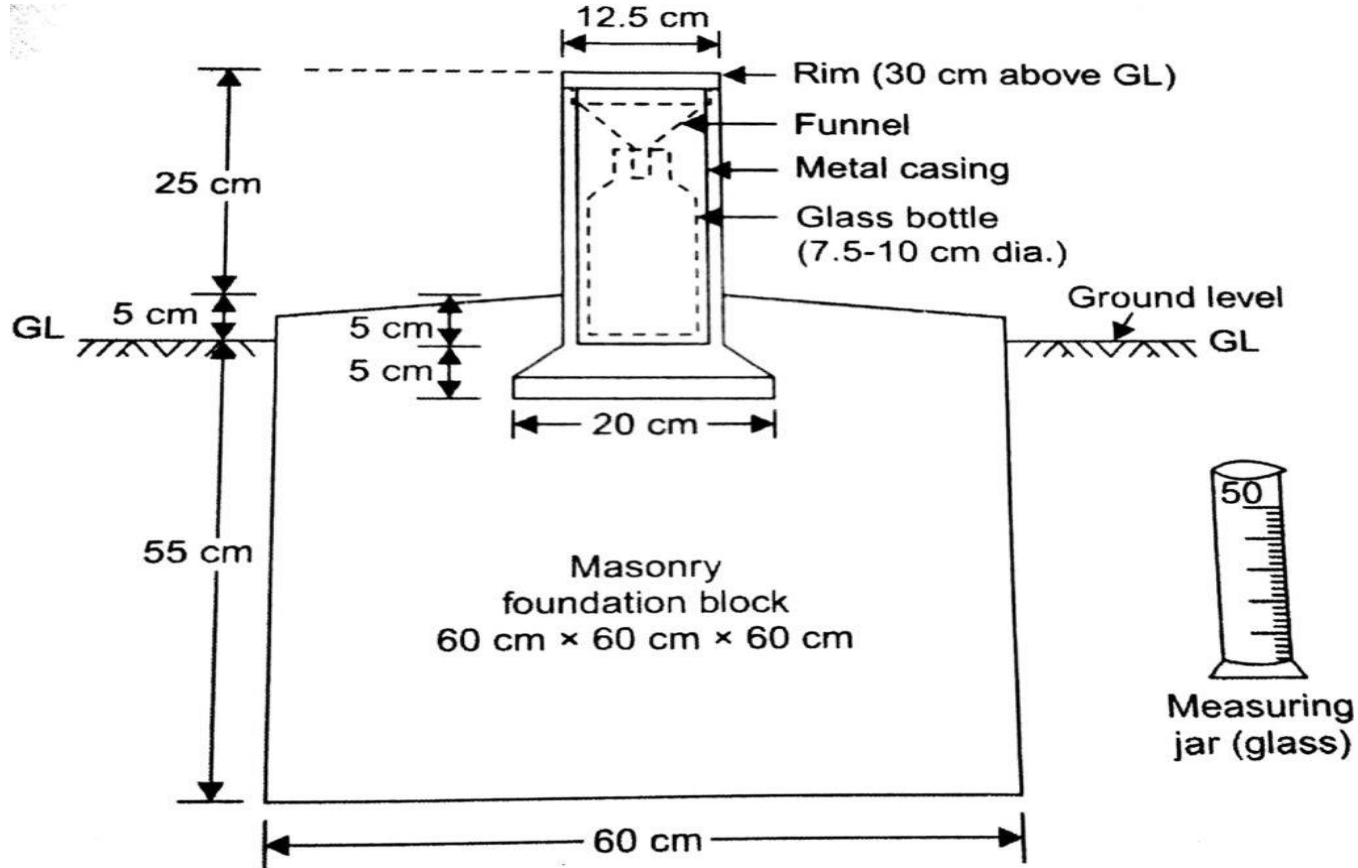



# Hydrology and Irrigation Engineering (18CV63)

## Module – 1: Hydrology and Precipitation

### **Non Recording Type of Raingauge:**

- The non recording raingauge that is extensively used in India is the SYMON's raingauge.
- It is essentially consists of a receiving funnel 127 mm in diameter, this funnel discharges the rainfall into a collecting vessel.
- The funnel and the receiver are housed in a metallic container as shown in figure.
- The so collected rainfall is accurately measured with the help of a carefully calibrated measuring jar.

# Hydrology and Irrigation Engineering (18CV63)

## Module – 1: Hydrology and Precipitation

### **Non Recording Type of Raingauge:**

- Generally, the rainfall is measured every day at 8.30 hours.
- However during heavy rains, it must be measured daily thrice or four times.
- Symons raingauge gives the total rainfall but not the intensity.
- It is very much essential to protect the gauge from being damaged by cattle or human beings and hence a fence is erected around it.

# Hydrology and Irrigation Engineering (18CV63)

## Module – 1: Hydrology and Precipitation

### **Non Recording Type of Raingauge:**

Following points are to satisfied while selecting the raingauge station.

- The site is true representative of the area for which the station is to give rainfall.
- The site is an open place.
- The site is a level ground.
- In hilly areas, the site should be selected that the gauge is protected from strong winds.
- The site is free from obstructions such as tall buildings, tree

# Hydrology and Irrigation Engineering (18CV63)

## Module – 1: Hydrology and Precipitation

### Recording Gauges:

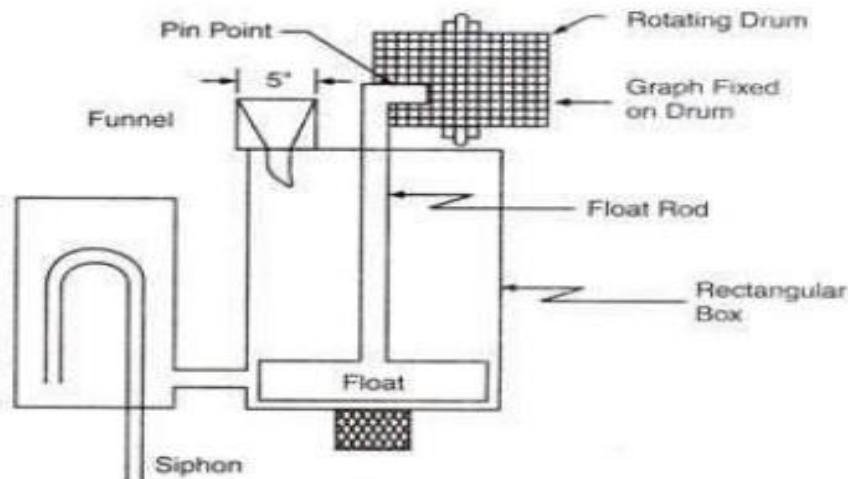

**Fig. 2.5.** Recording type rain-gauge



# Hydrology and Irrigation Engineering (18CV63)

## Module – 1: Hydrology and Precipitation

### **Recording Gauges:**

- Are devices or instruments used for measuring the rainfall at a place.
- Such type of gauges can give continuous record of rainfall with respect to time and hence provide valuable data of intensity and duration of the rainfall for hydrological analysis of storms.

### **Advantages:**

- No attendant is required to operate the recording gauge.
- Such a raingauge can be installed in remote and hilly areas.

# Hydrology and Irrigation Engineering (18CV63)

## Module – 1: Hydrology and Precipitation

### **Recording Gauges:**

#### **Advantages:**

- Human error can be eliminated by adopting such a gauge.
- Capacity of such a gauge is generally more than the non recording gauge.
- It can be operated for longer durations without much attention.

#### **Disadvantages:**

- Initial cost is high compared to the non recording gauge.
- The recording process may be disturbed.

# Hydrology and Irrigation Engineering (18CV63)

## Module – 1: Hydrology and Precipitation

### Syphon Type Raingauge:

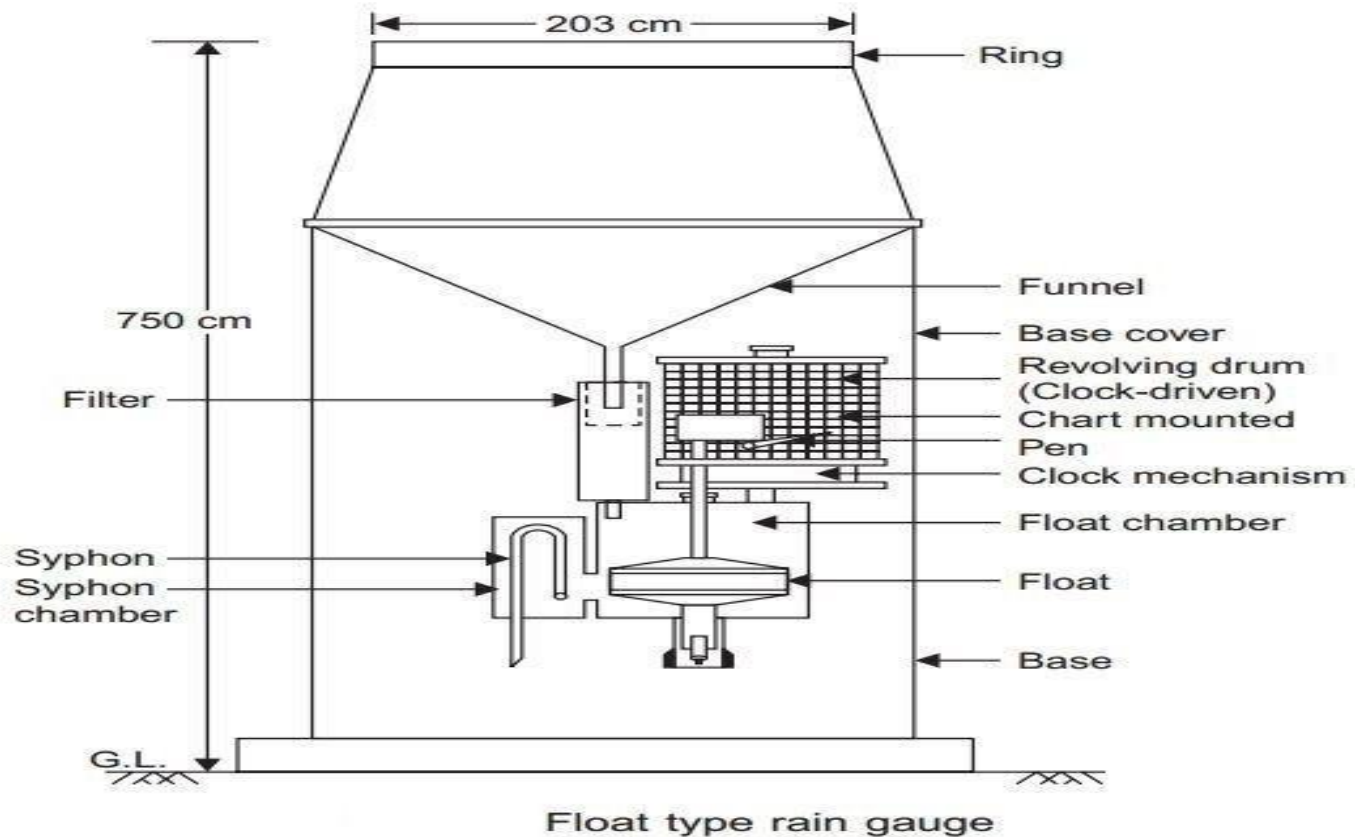

# Hydrology and Irrigation Engineering (18CV63)

## Module – 1: Hydrology and Precipitation

### **Syphon Type Raingauge:**

- It is also known as a float type of raingauge.
- It consists of a 127mm dia funnel, provided on one side of the top of rectangular float chamber, as shown in figure.
- As the water level rises in the chamber, the float also rises.
- The movement is thus transmitted on a pen arm moving on a revolving chart held on a clock driven drum.
- The pen arm plots the mass curve of the rainfall.
- As soon as the chamber fills, syphon comes into picture bringing back the float to its original lowest position.



# Hydrology and Irrigation Engineering (18CV63)

## Module – 1: Hydrology and Precipitation

### **Raingauge Density:**

- Means the number of raingauges that are to be installed in a given area, so that better and accurate results are possible.
- In India, on an average one raingauge is installed for every 500km<sup>2</sup> where as one station is installed for every 100km<sup>2</sup> in other developed countries.

The optimum number of raingauge stations that are necessary to gauge the average rainfall within a reasonable limit of error can be determined as follows:

# Hydrology and Irrigation Engineering (18CV63)

## Module – 1: Hydrology and Precipitation

### Raingauge Density:

- Calculate the total rainfall (R) over the given area as  $R = P_1 + P_2 + \dots + P_n$  where, n is the number of stations, P is the rainfall recorded at each station.

- Calculate the average rainfall (p) as  $p = (R/n)$ .

$$S_x^2 = [\Sigma (x_i - x)^2 / (n - 1)]$$

- Calculate  $C_v$

$$C_v = (S_x / x) * 100$$

- Calculate N for the given P

$$N = (C_v / P)^2$$

# Hydrology and Irrigation Engineering (18CV63)

## Module – 1: Hydrology and Precipitation

### **Average Rainfall Over a Catchment:**

- Raingauges represent only point sampling of the areal distribution of a storm, but hydrological analysis requires a knowledge of the rainfall over the catchment area.
- Hence the point rainfall values are converted into an average value or an equivalent uniform depths of the following methods.

Arithmetic Average Method

Thiessen's Polygonal Method

Isohyetal Method

# Hydrology and Irrigation Engineering (18CV63)

## Module – 1: Hydrology and Precipitation

### **Arithmetic Average Method:**

- Let  $P_1, P_2, \dots, P_n$  be the point rainfalls recorded during a particular storm by the  $n$  gauges.
- The average precipitation over the area can be calculated as:

$$P_{av} = (\Sigma P / n)$$

- This method is adopted to flat terrains where the gauges are uniformly distributed and the rainfall at different stations do not vary widely from the average value.
- In practice, this is not commonly used.

# Hydrology and Irrigation Engineering (18CV63)

## Module – 1: Hydrology and Precipitation

### Thiessen's Polygon Method:

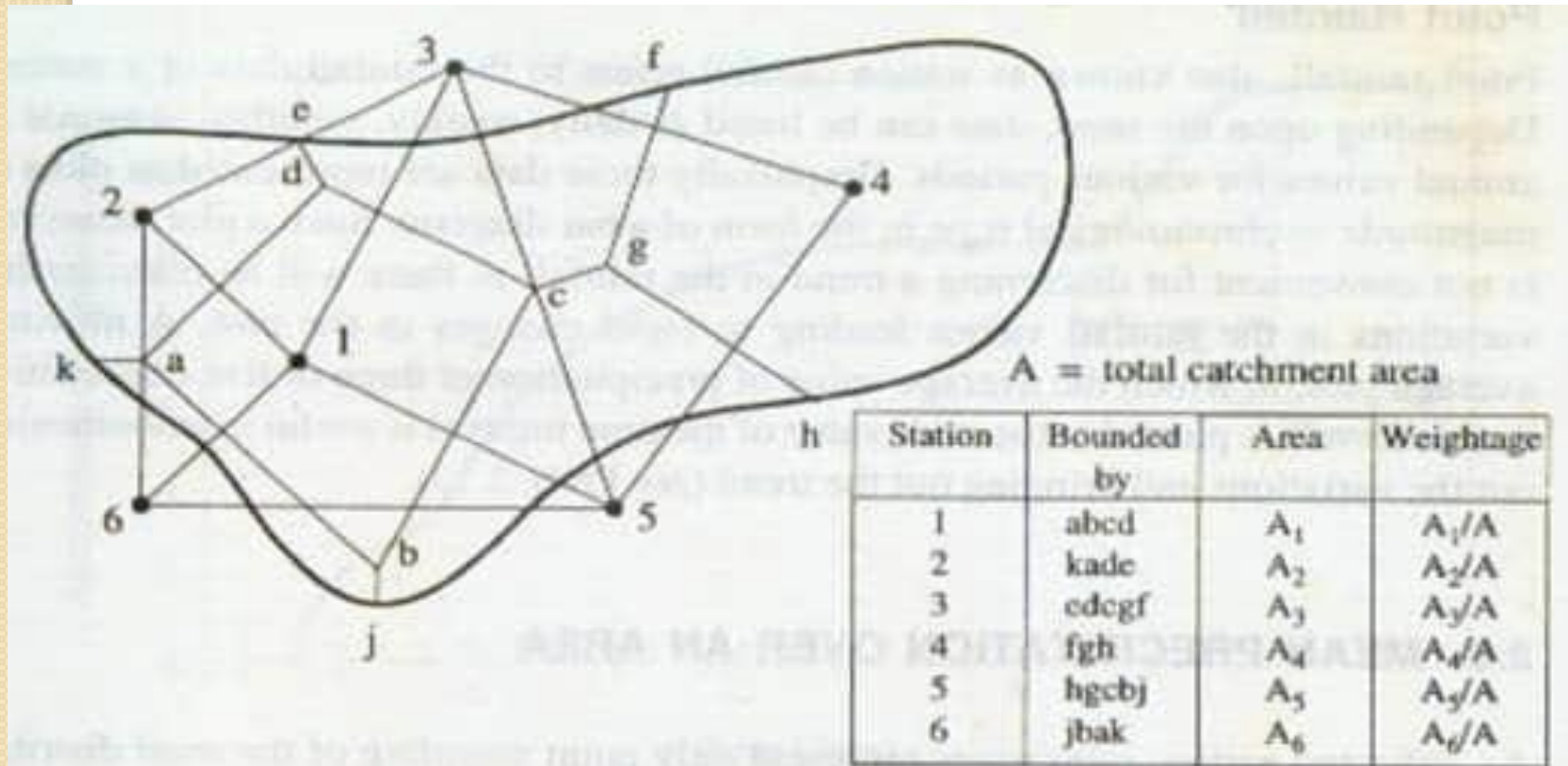

# Hydrology and Irrigation Engineering (18CV63)

## Module – 1: Hydrology and Precipitation

### **Thiessen's Polygon Method:**

- It is also known as the weighted mean method.
- Here the rainfall recorded at each station is given a weightage on the basis of an area closet to the station.

The procedure is as follows:

- Locate the positions of the raingauge stations A,B,C,D,E on the catchment map
- Join each adjacent station by a straight line.
- To each of these lines drops perpendicular bisector so that they form polygons.

# Hydrology and Irrigation Engineering (18CV63)

## Module – 1: Hydrology and Precipitation

### Thiessen's Polygon Method:

- Let  $P_1, P_2, \dots$  be the point rainfall at stations A, B, .....
- The average rainfall over the catchment is given by the equation.

$$P_{av} = [(P_1A_1) + (P_2A_2) + \dots + (P_nA_n) / A_1 + A_2 + \dots + A_n]$$

- This is a better method when compared with the arithmetic average method.
- It is suitable for areas which are plain and of intermediate size of the order of 750 to 3000km<sup>2</sup>.



# Hydrology and Irrigation Engineering (18CV63)

## Module – 1: Hydrology and Precipitation

### Isohyetal Method:

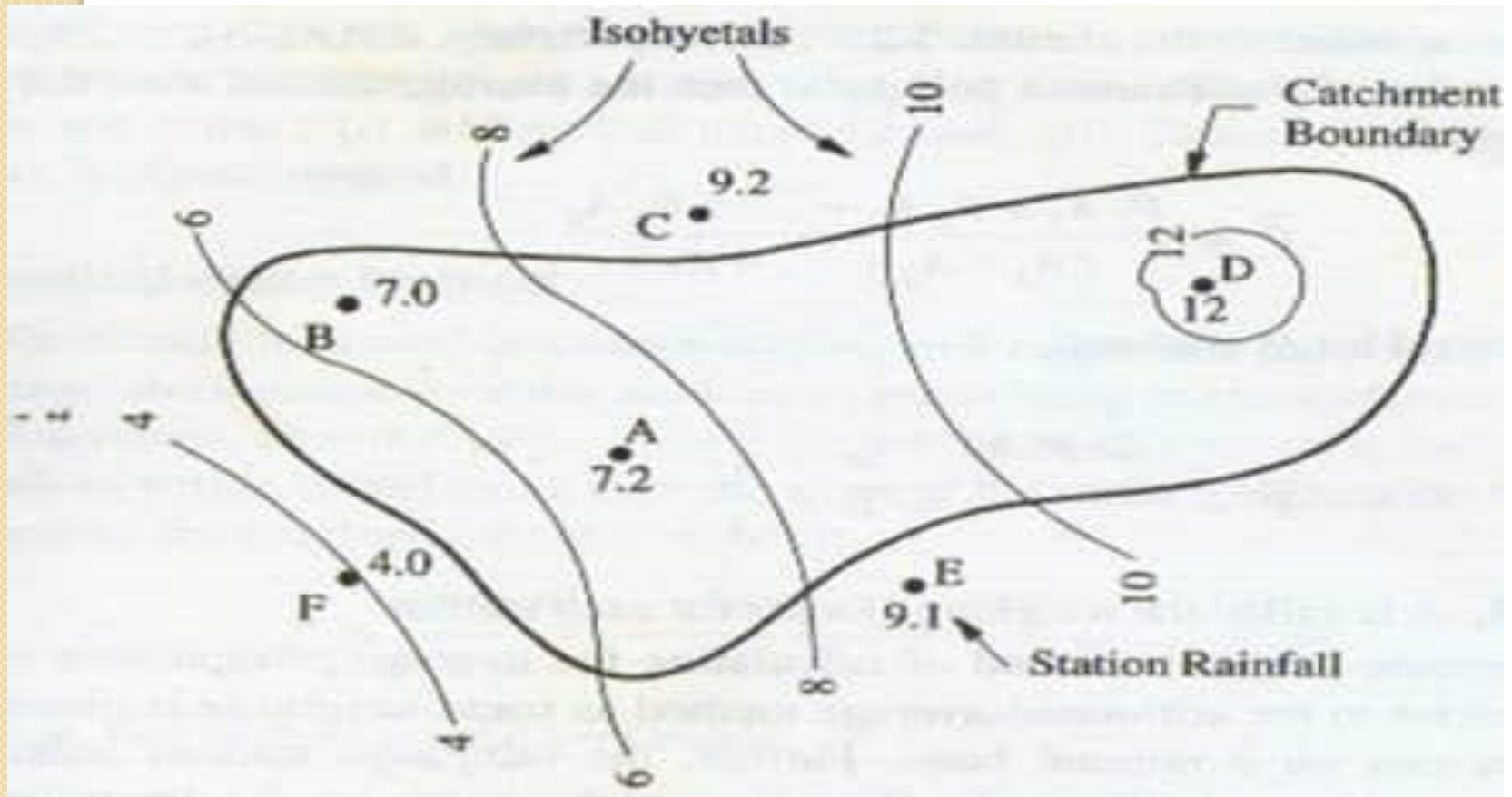



# Hydrology and Irrigation Engineering (18CV63)

## Module – 1: Hydrology and Precipitation

### **Isohyteal Method:**

- An isohytel is a line joining of equal rainfall.
- It is better when compared to the previous two methods.
- This method permits the use and interpolation of other nearby gauges and makes corrections accordingly.

The procedure as follows:

- The catchment area is drawn to a scale and the rain gauge stations marked on it.
- The lines of equal rainfall (isohytes) are drawn on the map, considering the orographic effect on the rainfall.

# Hydrology and Irrigation Engineering (18CV63)

## Module – 1: Hydrology and Precipitation

### **Isohyetal Method:**

- The area between the two adjacent isohyets is measured using a planimeter.
- In case, the isohyets go out of the catchment boundary line is used as the boundary line.
- The average rainfall over the catchment is calculated from the relation.

$$P_{av} = [ \{A_1 * (P_1 + P_2)/2 + \dots + A_{n-1} * (P_{n-1} + P_n)/2\} / A_1 + A_2 + \dots + A_n ]$$

# Hydrology and Irrigation Engineering (18CV63)

## Module – 1: Hydrology and Precipitation

### Adjustment of Missing Rainfall:

#### Normal Ratio Method:

- This method is applicable if the normal annual rainfall at the missing station X is within 10% of the adjoining three stations A,B and C.
- In this method the rainfall values at three stations are weighted by the ratio of the normal annual rainfall value N.

$$P_X = 1/3 * \{ (N_X/N_A)P_A + (N_X/N_B)P_B + (N_X/N_C)P_C \}$$

- In case there are M number of reference stations, then

$$P_X = (N_X/M) * \{ (P_A/N_A) + (P_B/N_B) + \dots + (P_m/N_m) \}$$

# Hydrology and Irrigation Engineering (18CV63)

## Module – 1: Hydrology and Precipitation

### **Adjustment of Rainfall Data:**

#### **Adjustment of Rainfall Data by Double Mass Curve Method:**

- A double mass curve is a graphical representation of the accumulated annual rainfall at a given station X, (plotted on Y-axis) whose consistency has to be checked, versus the average of the accumulated annual rainfall of a number of reference stations (plotted on X-axis).
- This technique is based on the fact that when each recorded data comes from the same parent population, they are consistent.

# Hydrology and Irrigation Engineering (18CV63)

## Module – 1: Hydrology and Precipitation

### **Adjustment of Rainfall Data:**

#### **Adjustment of Rainfall Data by Double Mass Curve Method:**

- Generally a graph of 5 to 10 base stations surrounding the station whose data is to be checked are taken as reference.
- The data of the annual or mean monthly rainfall of the station X and also the average rainfall of the number of reference stations is arranged in the reverse chronological order.

# Hydrology and Irrigation Engineering (18CV63)

## Module – 1: Hydrology and Precipitation

### Adjustment of Rainfall Data:

#### Adjustment of Rainfall Data by Double Mass Curve Method:

- The accumulated precipitation of the station  $X$  (i.e.  $\Sigma P_x$ ) and the accumulated values of the average group of the base stations (i.e.  $\Sigma P_v$ ) are calculated starting from the latest record.
- The values of  $\Sigma P_x$  are plotted on Y-axis along with the corresponding values of  $\Sigma P_v$  on X-axis as shown in figure.

# Hydrology and Irrigation Engineering (18CV63)

## Module – 1: Hydrology and Precipitation

### Adjustment of Rainfall Data:

#### Adjustment of Rainfall Data by Double Mass Curve Method:

- A discontinuity in the slope of the straight line indicates the deviation of data at station X.
- The so deviated values at the station X can be calculated from the relation.

$$P_{cx} = P_x * (S_c / S_a)$$

Where,  $P_{cx}$  = corrected precipitation at any period  $t_1$  at station X,  $P_x$  = original recorded precipitation at time  $t_1$

# Hydrology and Irrigation Engineering (18CV63)

## Module – 1: Hydrology and Precipitation

### **Adjustment of Rainfall Data:**

#### **Adjustment of Rainfall Data by Double Mass Curve Method:**

Where,  $S_c$  = corrected slope of the double mass curve,  $S_a$  = original slope of the mass curve.

- The double mass curve is also helpful in checking arithmetical errors in transferring the rainfall data from one record to another.



# Hydrology and Irrigation Engineering (18CV63)

## Module – 1: Hydrology and Precipitation

### Adjustment of Rainfall Data:

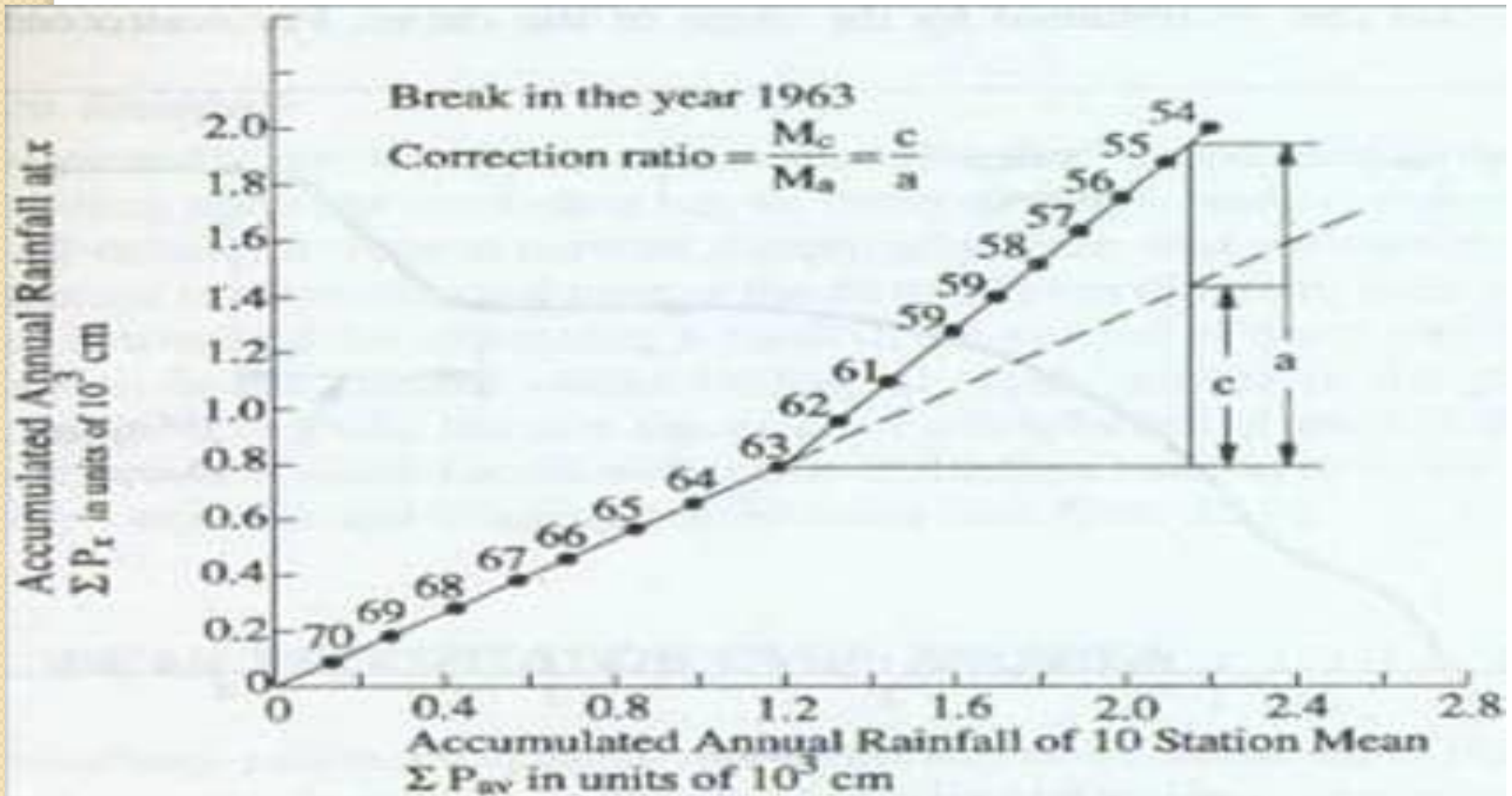

# Hydrology and Irrigation Engineering (18CV63)

## Module – 1: Hydrology and Precipitation

### **Presentation of Precipitation Data:**

#### **Hyetograph:**

- An hyetograph is a graphical representation in the form of a bar chart of the intensity of rain with respect to time as shown in figure.
- It is the most convenient of representing the characteristics of a storm and is particularly important in the calculation of extreme floods.
- The area under the hyetograph gives the total precipitation during a particular period of time.

# Hydrology and Irrigation Engineering (18CV63)

## Module – 1: Hydrology and Precipitation

### Presentation of Precipitation Data:

### Hyetograph:

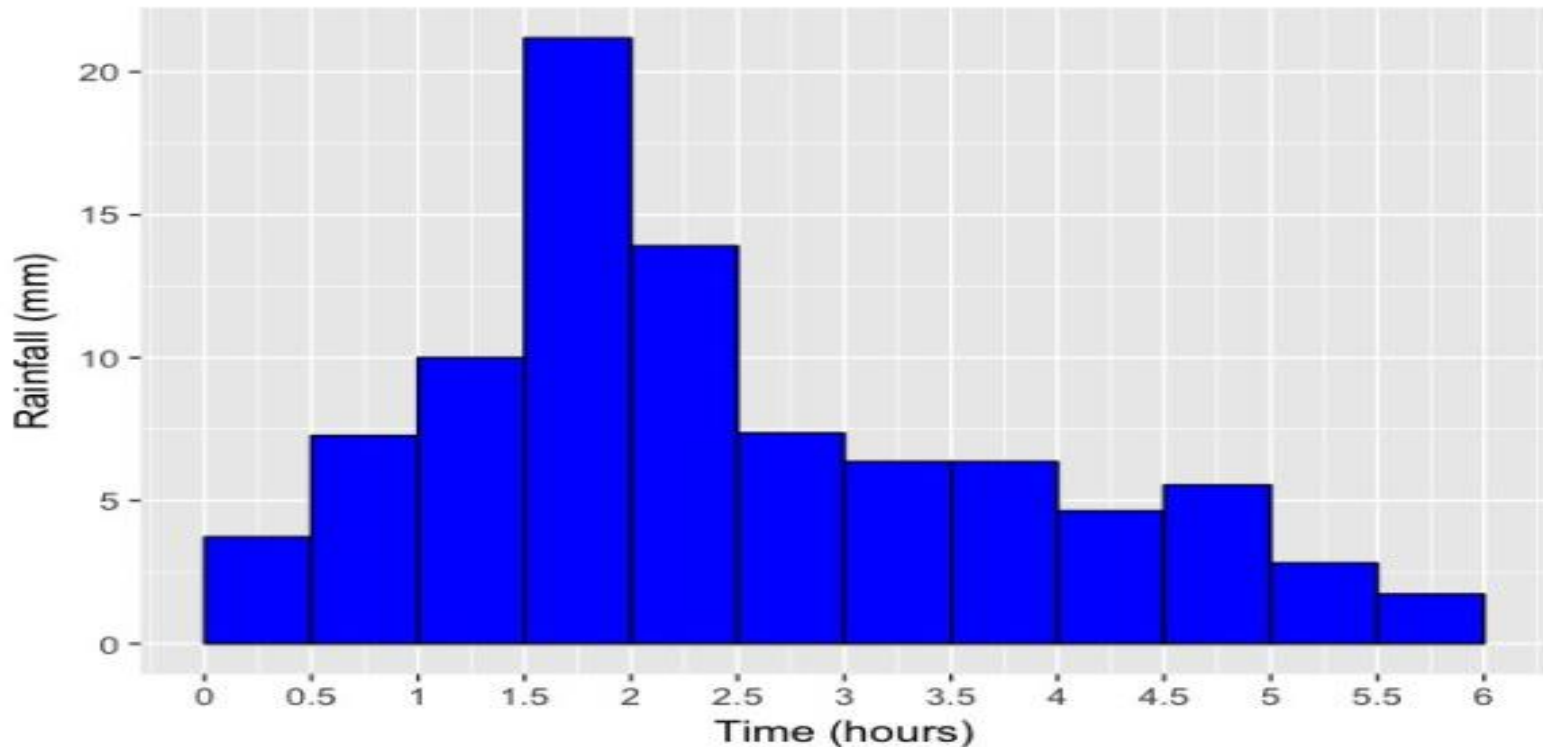

# Hydrology and Irrigation Engineering (18CV63)

## Module – 1: Hydrology and Precipitation

### Presentation of Precipitation Data:

#### Mass Curve:

- Mass curve is a graph showing the cumulative depth of rainfall against time.
- An automatic or recording raingauge records the rainfall in the form of a mass curve.
- Figure represents a typical mass curve of rainfall.
- The instantaneous slope of the mass curve gives the rainfall intensity.
- It is obvious that if the slope of mass curve is zero, the intensity of rainfall is zero.

# Hydrology and Irrigation Engineering (18CV63)

## Module – 1: Hydrology and Precipitation

### Presentation of Precipitation Data:

#### Mass Curve:

### PRESENTATION OF RAINFALL DATA

Mass Curve of Rainfall

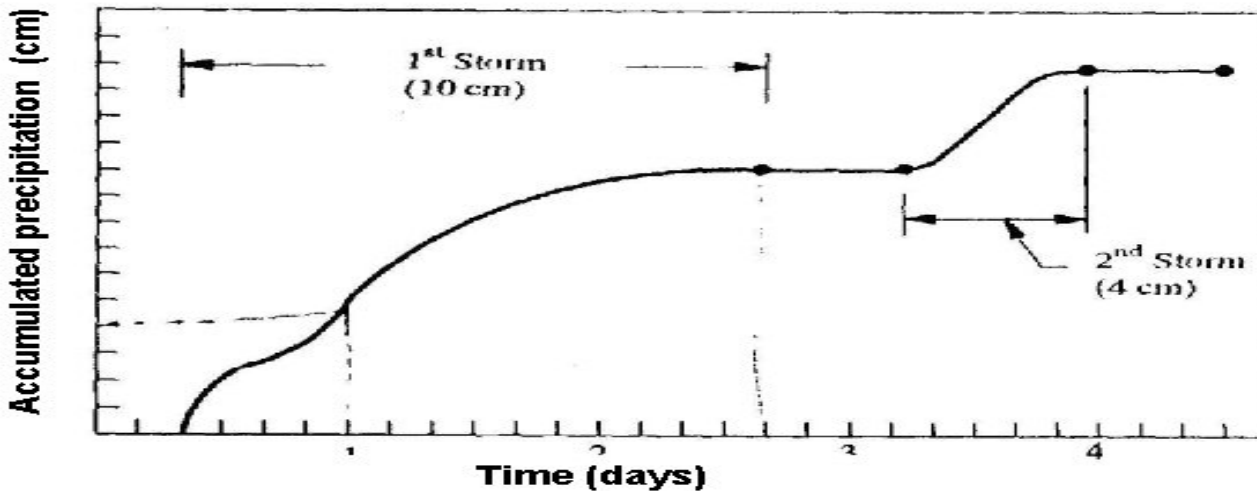

# Hydrology and Irrigation Engineering (18CV63)

## Module – 1: Hydrology and Precipitation

### Presentation of Precipitation Data:

#### Moving Average Curve:

- The moving average curve smoothens out the extreme variations and indicate the trend or cyclic pattern, if any more clearly and is known as moving mean curve the moving average curve is constructed with a moving period of  $m$  year where  $m$  is considered as 3 or 5 years.
- Let  $X_1, X_2, \dots, X_n$  be the sequence of given rainfall in the chronological order.
- Let  $Y_1$  denote the ordinate of the moving average for the  $I$  year.

# Hydrology and Irrigation Engineering (18CV63)

## Module – 1: Hydrology and Precipitation

### Presentation of Precipitation Data:

#### Moving Average Curve:

Then for  $m=3$ ,  $Y_i$  is computed as:

$$Y_2 = (X_1 + X_2 + X_3 / 3)$$

$$Y_3 = (X_2 + X_4 + X_5 / 3)$$

$$Y_i = (X_{(i-1)} + X_i + X_{(i+1)} / 3)$$

- It is clear that the calculated value of  $Y$  corresponds in time to the middle value of  $X$  values being average and therefore is convenient to use odd values of  $m$ .



# Hydrology and Irrigation Engineering (18CV63)

## Module – 1: Hydrology and Precipitation

### Presentation of Precipitation Data:

#### Moving Average Curve:

- A moving average of  $m$  applied to a sequence of  $n$  values yields a sequence of  $(n-2k)$  values, where  $k = (m-1) / 2$  for any general  $m$ , the  $Y$  terms can be expressed as
- $Y_i = (1/m) \{ \sum_{j=i-k}^{i+k} X_j \}$  for  $i = k + 1, k + 2, \dots, (n-k)$
- Although it is possible to use moving average with any  $m$ , it is necessary that  $m$  be small compared to  $n$ .
- Generally no persistent regular cycles can be expected in the annual rainfall data.